

LANTC17056

Installation Instructions

Lankota Tow Cable Kit for John Deere 8X30, 8X30T, 8R, 8RT & 8RX Tractors

LANTC18241 is required when front weights or weight bracket is removed

LANTC24598 is required on tractors with factory fender tanks

LANKOTA®

270 West Park Avenue
Huron, SD 57350
866-526-5682

















Numerical Parts List

Part Numbers	Description	Qty
LANTC157	Tow Cable—1.25" x 16ft	1
LANTC209	Shackle, 1-3/8" Bolt Type	1
LAN8RTC004	Pulling Plate	2
LAN8RTC005	Top Cable Support Bracket	1
LAN8RTC006	Cable Clamp	2
LAN8RTC007	Cable Stow Hook	1
LAN8RTC010	Stow Backer Plate	1
LAN8RTC011	Stow Chain	1
LAN8RTC016	Tow Cable Hanger Bar	1
LAN8RTC017	Tow Cable Hanger Left Leg	1
LAN8RTC018	Tow Cable Hanger Right Leg	1
LAN8RTC019	Main Anchor Weldment	1
LAN8RTC020	Plate Spacer	2
LAN8RTC022	Cat 3 Reducing Bushing	1
LAN-JDTC105	Cable Retaining Latch	1
LANTBJJ7818	Turnbuckle, 7/8" x 18", Jaw-Jaw	2
LANSS704	Twist-Lock Pin	1

Numerical Parts List

Part Numbers	Description	Qty
LANTC17056BH	Box of Hardware	1
LANFHG3	5/16" Spring Link Carabiner	1
LANFNBF9	7/8" Jam Nut	2
LANF1SA3	M20 x 55 Hex Bolt, Cls 8.8	3
LANF-FW-M20	M20 Flat Washer	3
LANF1ERQ	1/2" x 2" Carriage Bolt	4
LAN3722	1/2" Serrated Flange Nut	4
REDB707	5/8" x 1.75" Hex Bolt	1
REDB710	5/8" x 2.5" Hex Bolt	2
LAN26000	5/8" Flat Washer	2
REDKRJF	5/8" Top Lock Nut	1
LAN690830	5/8" Serrated Flange Nut	2
LANFM7KV	3/8" x 1 Serrated Flange Bolt	2
LAN3718	3/8" Serrated Flange Nut	2
LANF-BZBS-0.69-0.50	Bronze Bushing	1
LAN2600UBOLT	U-Bolt, 5/8" x 4"	1

Pictorial Parts List

Pictorial Parts List

					
LANFNBF9 (2)	LANFHG3 (1)	LANF1SA3 (3)			LANF-FW-M20 (3)
					
LANF1ERQ (4)	LAN3722 (4)	REDB707 (1)	REDB710 (2)	LAN26000 (2)	REDKRJF (1)
					
LAN690830 (2)	LANFM7KV (2)	LAN3718 (2)	LAN2600UBOLT (1)	LANF-BZBS-.69-.5 (1)	

Preparation

1. Unhook any implement from the tractor.
2. Park the tractor on a flat, hard surface.
3. Set the parking brake on the tractor.
4. Turn off the engine and remove the key.

Kit Installation

***If your tractor has factory fender tanks, you will need to also have LANTC24598 to proceed with the installation**

Refer to Figure 1 & 2

1. Remove the right hand threaded end of each turnbuckle, install jam nut (LANFNBF9), and reassemble.
2. Remove the four M20 bolts holding the drawbar front support and draw bar pin. These bolts, pin and pin retainer plate will be reused.
3. Be sure the mounting surface, pin bore, and threaded holes are clean and free of debris.

Figure 1

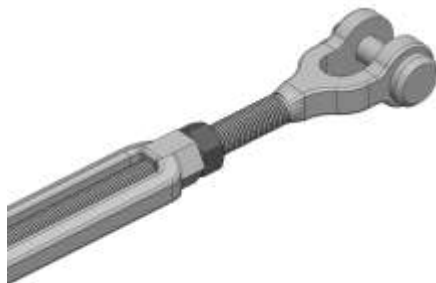

Figure 2

Kit Installation (8RT Only)

Refer to Figures A - C

- Remove lower skid guard located beside and in front of the drawbar front support.
- With the skid guard laying as show, cut along the white lines.
- Re-install skid guard onto tractor.



Figure B



Figure A



Figure C

Kit Installation

Refer to Figures 3 - 5

4. Install 8RTC019 with the large hole pointing toward the front of the tractor. Hand tighten the previously removed bolts through spacer blocks 8RTC020, one on each side.
5. Install the spacer blocks so the longer edge is down and pointing forward as shown.
6. **Feed the drawbar pin up from the bottom through 8RTC019 and use the original pin retainer plate to hold the pin in place. (Figure 4—side plates not shown.)**
Note: For Category 3 drawbars, install the reducing bushing (8RTC022) between the pin and the tow bracket (8RTC019).
7. Tight all four bolts and the pin retainer bolt.



Figure 3

Figure 5



Figure 4



Kit Installation

Refer to Figures 6 - 8

8. Move to the center section of the tractor and remove the black soft plugs in three of the tapped M20 holes.
9. Install hanger bracket legs 8RTC017 & 8RTC018 (one on each side of the tractor) with (LANF1SA3) bolts and (LANF-FW-M20) washers. The hanger brackets can be flipped to either side of the tractor to avoid step mounts, toolbox mounts, etc. Tighten bolts.
10. Feed the tow cable (LANTC157) in from the front of the tractor and towards the rear of the tractor.
11. Remove the R side of both turnbuckle rods and thread the jam nut (LANFNBF9) onto the studs before replacing the.
12. Moving back to the drawbar, install one end of both turnbuckles onto plate 8RTC019 and replace the pins and cotter pins.



Figure 6



Figure 7



Figure 8

Kit Installation

Refer to Figures 9 - 11

13. While holding the loose end of the turnbuckle from spinning, thread the center portion of the turnbuckle out until the end can be attached to 8RTC004 on each side.
14. Install the turnbuckle pins and cotter pins. Tighten the turnbuckles, then tighten the turnbuckle jam nuts (LANFNBF9) to prevent the turnbuckles from coming loose.
15. Attach the tow cable to 8RTC019 with the shackle (LANTC209), tighten the shackle nut and install the cotter pin.



Figure 9



Figure 10



Figure 11

Kit Installation

Refer to Figures 12 - 15

16. Bolt the top support bracket (8RTC005) and the hanger bar (8RTC016) on the hanger bar legs at the center of the tractor. Use four carriage bolts (LANF1ERQ) and serrated flange nuts (LAN3722).
17. Using a forklift or other suitable pulling device, gently pull on the tow cable to take the slack out of the center.
18. Bolt cable clamp halves (8RTC006) over the cable against the front side of the hanger support with flange bolts (LANFM7KV) and serrated flange nuts (LAN3718).
19. Included in the kit are a number of different front cable stow options.
Recommended Use:
 - *Tractor with rollers, accessories: 8RTC007 with U-bolt*
 - *8RT (Track Tractors): 8RTC007 & 8RTC010 onto weights*
 - *Tractor with weights: Chain and Carabiner*
 - *Tractor without weights: LANTC18241 (Next Section)*

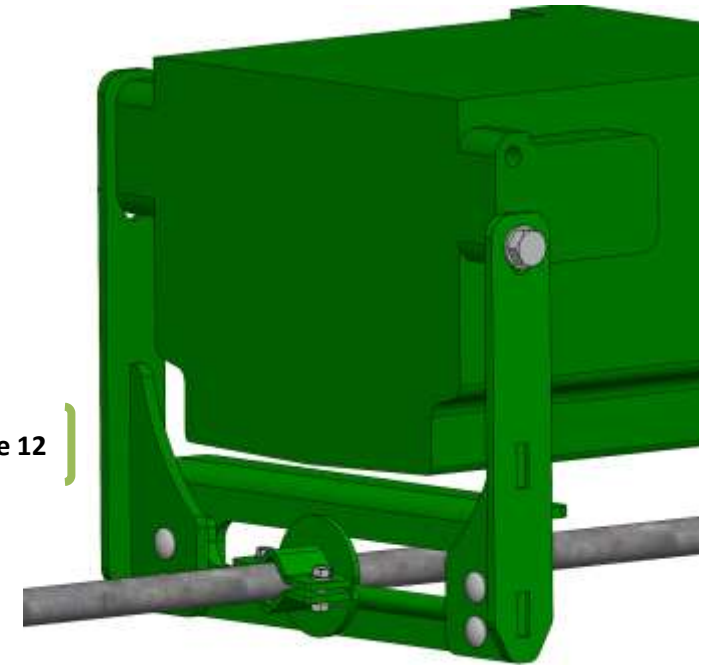

Figure 12

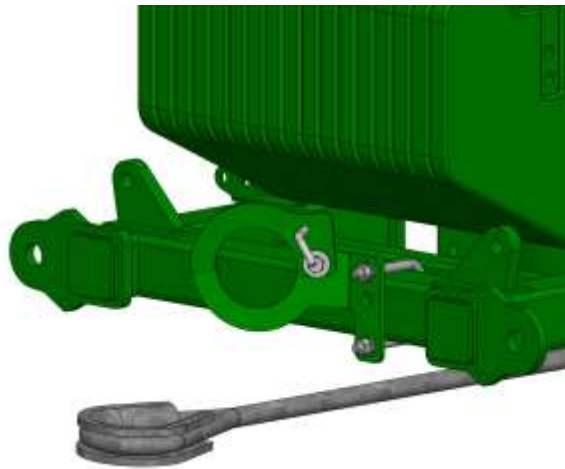

Figure 13



Figure 14



Figure 15



**For further technical assistance,
Call Lankota Inc. at:
1-866-526-5682**