

LANUDCIH2000K

Installation Instructions

CASE IH® 6088 & 7088 Series Combine Unloading Auger Electric Clutch Disengage System

The initial burnish process of the clutches contained in this kit has been performed by Lankota prior to shipment.

DO NOT USE WITH AN AUTOMATIC LUBRICATION SYSTEM!

LANKOTA®

270 West Park Avenue
Huron, SD 57350
866-526-5682

Numerical Parts List

Part Numbers	Description	Qty
LANUDCIH1100	Clutch Mount Bracket Assembly	1
LANCIH60A45	Sprocket - #60, 45 Teeth	1
LANCIH60A43	Sprocket - #60, 43 Teeth	1
LANUDCIH1004	Sprocket Hub	2
LANUDCIH1005	Sprocket Spacer	4
LANUDCIH2006	Clutch Spacer	2
LANUDCIH1007	Keyed Washer	10
LANGT5C-LK01	Electro Magnetic Clutch - REAR	1
LANGT5C-LK02	Electro Magnetic Clutch - FRONT	1
LAN47577188	Bearing Lock Collar	2
LAN44302	Zip Ties	10
LANUDJD1004	Sprocket Shim	6

Numerical Parts List

Part Numbers	Description	Qty
LANUDCIH1000KBH	Bag Of Hardware	1
-----	5/16" SAE Flat Washer	4
-----	M12-1.75 X 60mm, Grade 8.8 Bolt	2
-----	M12 Lock Washer	2
-----	M8-1.25 X 25mm, Grade 8.8 Bolt	16
-----	M8-1.25 X 35mm, Grade 8.8 Bolt	12
-----	M8-1.25 X 45mm, Grade 8.8 Bolt	12
-----	M8 Lock Washer	24
-----	5/8" SAE Flat Washer	10
-----	M8 Nyloc Nut	4
-----	Key - 8 x 10 x 40mm	2
 LANHT9261	 Wiring Harness Bundle	 1
-----	Cab Extension Harness	2
-----	Clutch Harness	1
-----	Cab Foot Switch	1
-----	Power Harness	1

Pictorial Parts List

 <p>LANUDCIH1100 (1)</p>		 <p>LANCIH60A45 (1)</p>	 <p>LANCIH60A43 (1)</p>	
 <p>LANUDCIH1004 (2)</p>	 <p>LANUDCIH1005 (4)</p>	 <p>LANUDCIH2006 (2)</p>	 <p>Power Harness</p>	 <p>Clutch Harness</p>
 <p>Cab Foot Switch</p>	 <p>Cab Extension Harness</p>	 <p>LANGT5C-LK01 (1)</p>	 <p>LANGT5C-LK02(1)</p>	

Pictorial Parts List

				
Wiring Kit Bag of Hardware	M8 x 25mm Bolt (16)	M8 Nyloc Nut (4)	5/16" SAE Flat Washer (4)	M12 x 60mm Bolt (2)
				
M12 Lock Washer (2)	M8 Lock Washer (24)	M8 x 35mm Bolt (12)	LANFWS57 (10)	LANUDJD1004 (6)
				
LAN44302 (10)	LANUDCIH1007 (10)	LAN47577188 (2)	Key—8 x 10 x 40mm (2)	M8 x 45mm Bolt (12)

**For further technical assistance,
Call Lankota Inc. at: 1-866-526-5682**

1. Preparation

Refer to Figures 1 & 2

1. Unload/Empty the grain tank.
2. Open L/H main access door on combine, exposing the unloading auger drive chain system.
3. Loosen drive chain tensioner completely.
4. Remove drive chain, letting it hang in place for later reinstallation.
5. Measure the gap between the grain tank and the sprockets. This will help line up the new sprockets with the drive chain.
6. Remove both grain tank cross auger drive sprockets from auger shafts. Leave square shaft key installed on shafts just as they are.
7. Use emery cloth to clean any scuffs, burs or paint from the shafts. This will make installation of new components much easier.

Figure 1



Figure 2



1. Preparation

8. Bolt the 45 tooth sprocket to the clutch as shown in the drawing below.

This kit requires the LANGT5C-LK01 clutch to be attached to the 45 tooth sprocket and placed on the REAR unloading auger shaft!!

ITEM NO.	PART NUMBER	DESCRIPTION	QTY.
1	LANGT5C-LK01	REAR CLUTCH	1
2	LANCIH60A45	SPROCKET - CIH - NO. 60, 45 TOOTH	1
3	LANUDCIH1004	SPROCKET HUB	1
4	METRIC BOLT	HHCS - M8-1.25 X 35, GR. 8.8	6
5	LAN201027	HHCS - M8-1.25 X 25, GR. 8.8	6
6	LANUDCIH1005	SPROCKET SPACER	1
7	LANFRWNF	LOCK WASHER - M8	12

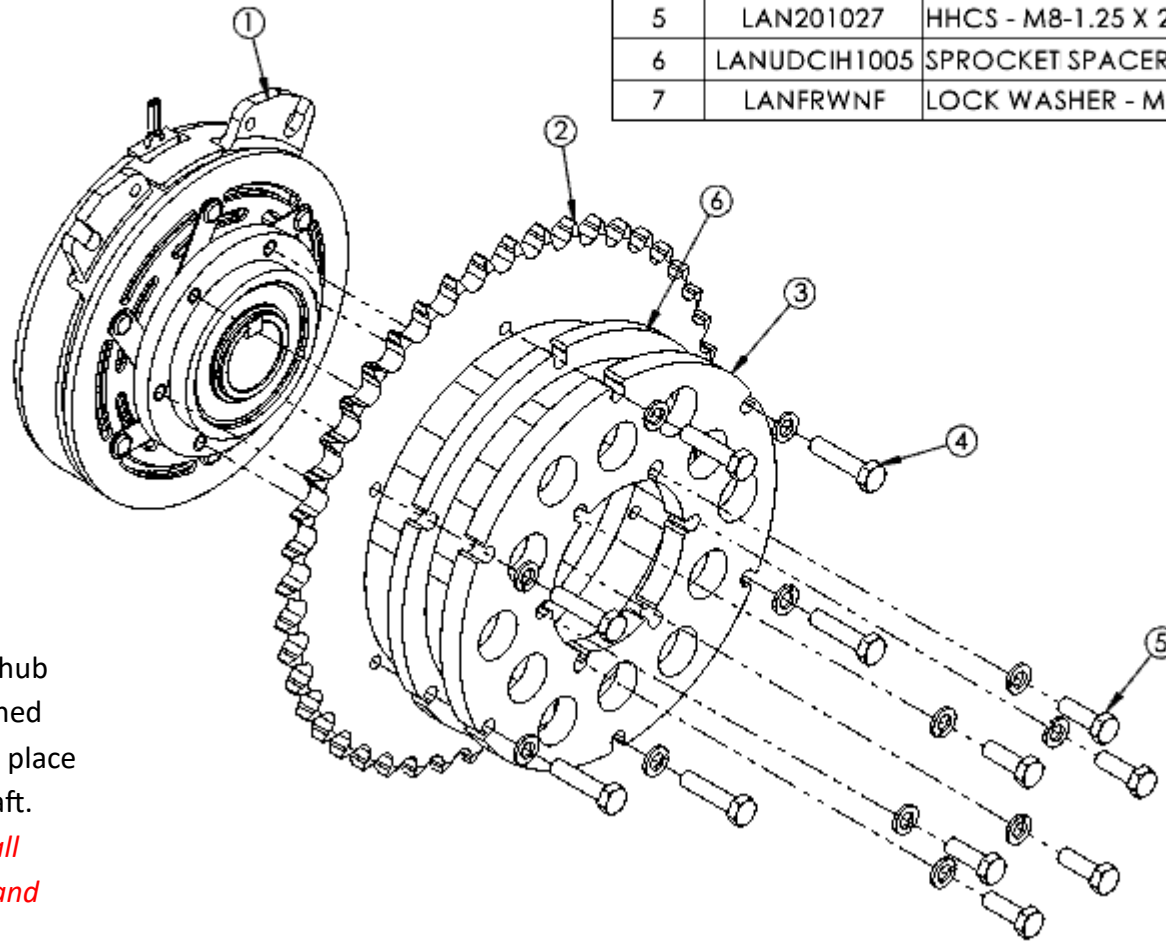

NOTE: At least two shims (LANUDJD1004) should be used between the clutch and sprocket hub to ensure hub bolts can be tightened and 5/8" washers are provided to place between the clutch and auger shaft.

The installer needs to make sure all sprockets run on the same plane and line up with the chain properly!

1. Preparation

9. Bolt the 43 tooth sprocket to the clutch as shown in the drawing below.

This kit requires the LANGT5C-LK02 clutch to be attached to the 43 tooth sprocket and placed on the FRONT unloading auger shaft!!

ITEM NO.	PART NUMBER	DESCRIPTION	QTY.
1	LANGT5C-LK02	FRONT CLUTCH	1
2	LANCIH60A43	SPROCKET - CIH - NO. 60, 43 TOOTH	1
3	LANUDCIH1004	SPROCKET HUB	1
4	LANFRWNF	LOCK WASHER - M8	12
5	METRIC BOLT	HHCS - M8-1.25 X 35, GR. 8.8	6
6	LAN201027	HHCS - M8-1.25 X 25, GR. 8.8	6
7	LANUDCIH1005	SPROCKET SPACER	1

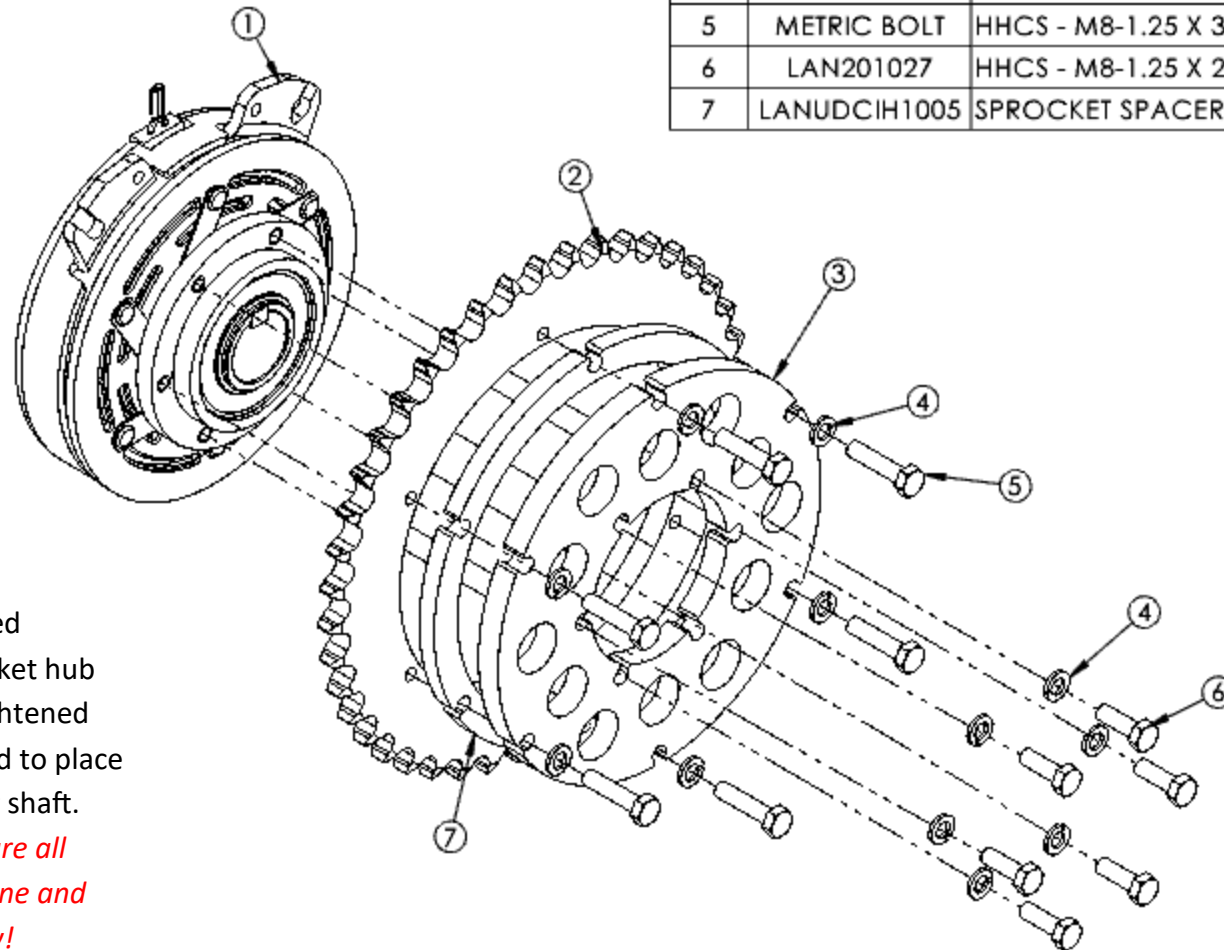

NOTE: At least two shims (LANUDJD1004) should be used between the clutch and sprocket hub to ensure hub bolts can be tightened and 5/8" washers are provided to place between the clutch and auger shaft.

The installer needs to make sure all sprockets run on the same plane and line up with the chain properly!

1. Preparation

Refer to Figure 3

NOTE: Use either the factory or provided key(s) for proper clutch/shaft engagement. You may need some light sanding to properly fit the key.

10. Mount one of the clutches. Measure between the grain tank and sprocket; compare this with the previous measurement.
11. Use the 5/8" flat washers (LANFWS57) or the clutch spacer (LANUDCIH1006) inside the clutch to move the sprocket out, OR the sprocket shims (LANUDJD1004) between the sprocket and clutch to move it in.
12. When the sprocket is set, examine the shaft behind the clutch and then remove the clutches:
 - a) If the locking collar (LAN47577188) will fit, remove the shaft keys and install the (2) eccentric lock collars on the shafts. Then replace the keys.
 - b) If the lock collars will not work, leave the keys in place and fill the space with the keyed washers (LANUDCIH1007).

Figure 3

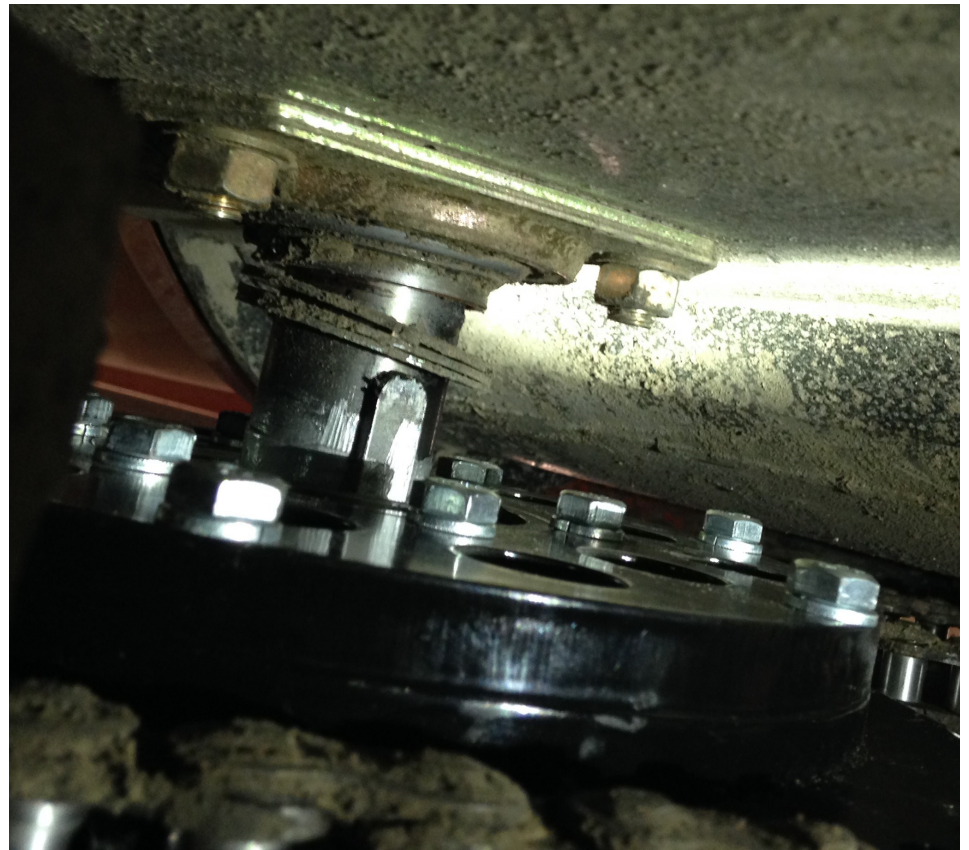

2. Kit Installation

Refer to Figure 4

NOTES:

- It is **STRONGLY** recommended that anti-seize be applied to the auger shaft before installing the clutch & sprocket assembly.
 - Use a small amount of thread locking compound on each bolt to secure clutch/sprocket assembly to drilled shafts.
1. Using the 5/8" flat washers (LANFWS57) or the clutch spacer (LANUDCIH1006) inside the clutch, **OR** the sprocket shims (LANUDJD1004), make sure the sprocket lines up with the chain properly when the sprocket assemblies are placed on the auger shaft. Fasten using one M12-1.75 x 60mm Grade 8.8 Bolt with thread locking compound and one M12 Lock Washer per shaft. Make sure the 45 tooth sprocket is on the rear shaft and the 43 tooth sprocket is on the front shaft. The grain tank unload augers will need to be kept from rotating to tighten these bolts.
 2. Install the chain onto the sprockets in the same manner it was taken off.



Figure 4

2. Kit Installation

Refer to Figure 5

1. Locate four M8-1.25 x 25mm Grade 8.8 Bolts, four M8 Nyloc Nuts and four 5/16" SAE Flat Washers from the supplied bag of hardware and use to attach the Clutch Mount assembled earlier to both front and rear clutch assemblies. Tighten the hardware at this time.
2. Tighten the unload drive chain as outlined in the COMBINE OPERATOR'S MANUAL.



Figure 5

3. Rear Wiring Harness Installation

Refer to Figure 6

The supplied wiring harness has two different style connector ends to fit many different model combines. Choose the connectors that match your combines connectors.

1. Access the left side of the combine.
2. Locate the unloading auger solenoid wiring connectors on the left side of machine.
3. From the supplied wiring harness kit, locate the Main Rear Harness which is the longest wiring harness wrapped with a braided cover which has several connector ends.
4. Connect the wiring harness to the connectors on the combine.
5. Whichever connectors do not get used, connect those to each other.
6. Secure wires with a zip tie.



Figure 6

Route wiring harness similar to the next figures. Secure harness as needed using supplied bag of hardware that came in the wiring bundle and/or the supplied zip ties (LAN44302). The harness is indicated with a yellow arrow. Route may differ depending on combine model.

3. Rear Wiring Harness Installation

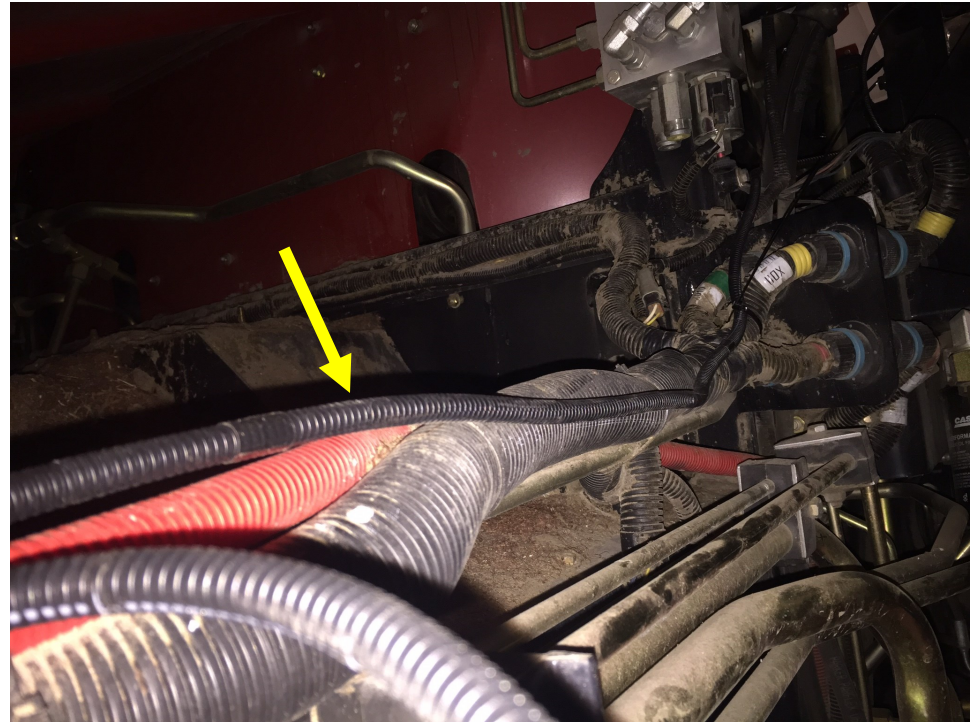
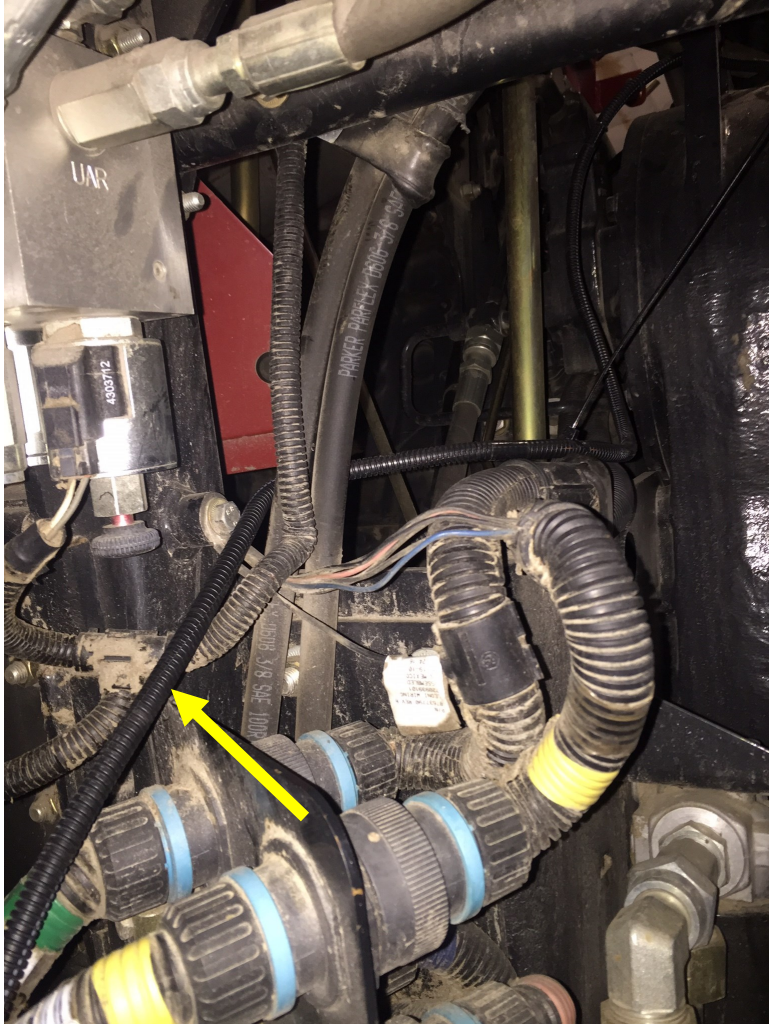

3. Rear Wiring Harness Installation



Refer to Figure 7

7. Route the clutch harness to the clutches and plug into the clutch wire leads.
8. Attach the ground wire to a nearby bolt on the frame (ensure a good connections)
9. Secure all wires with zip ties to avoid any damage.

Figure 7



3. Rear Wiring Harness Installation

Refer to Figure 8

10. Continue harness forward along the hinge point of the large L/H main access door.
11. Attach harness where you can to avoid any damage during operation of combine and/or opening and closing of the side shield.

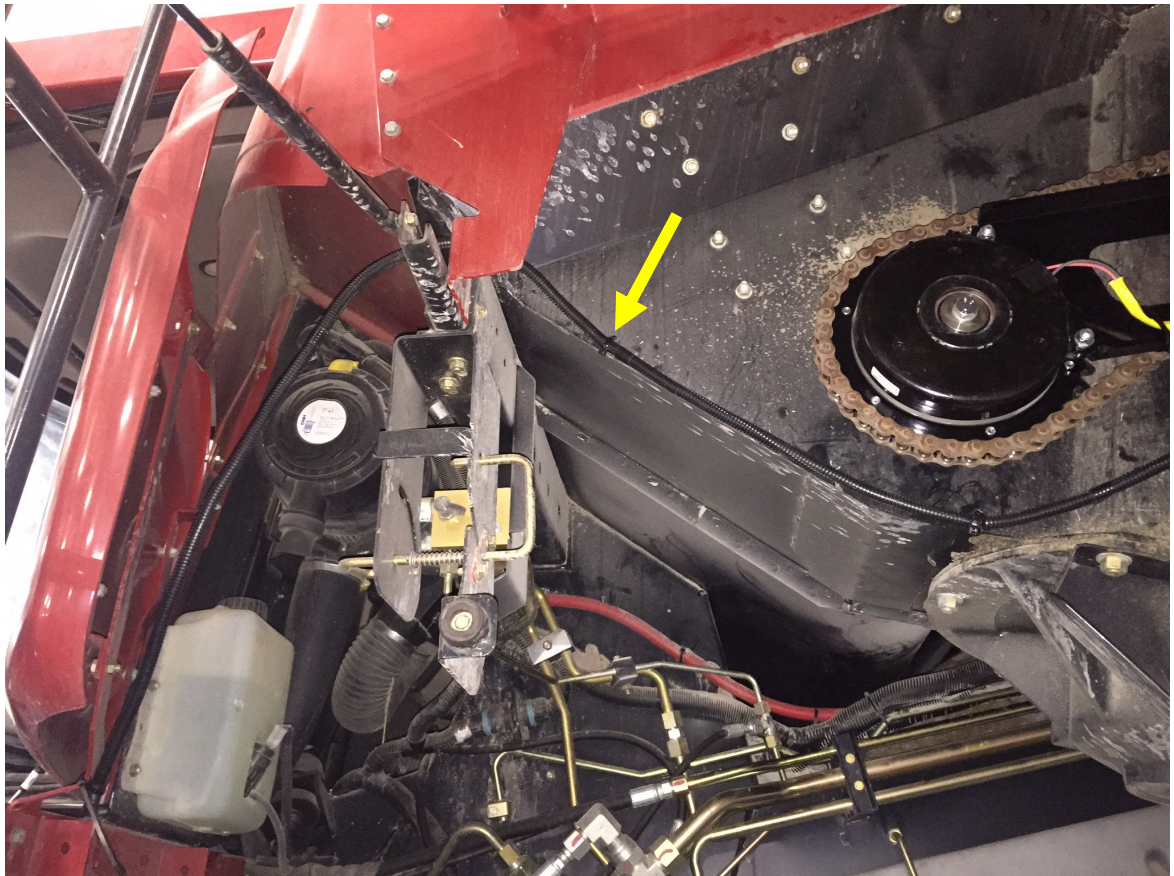

Figure 8

3. Rear Wiring Harness Installation

Refer to Figure 9

12. Run harness below the walking platform as close to the cab access door as you can.
13. Secure where you can to avoid damage to harness.

This harness WILL NOT continue into combine cab.

Figure 9



4. Cab Wiring Harness Installation

Refer to Figures 10 & 11

NOTE: BEFORE PROCEEDING, DISCONNECT ANY BATTERY POWER SOURCE TO THE CAB.

1. Locate Power Harness from wiring bundle. This harness has eyelets on a black and red wire and a plug on the other end.
2. Locate and remove the fuse panel cover (red arrow). Connect the power eyelet to the bolt indicated with the gold arrow and the ground wire to the bolt indicated with the blue arrow.



Figure 10

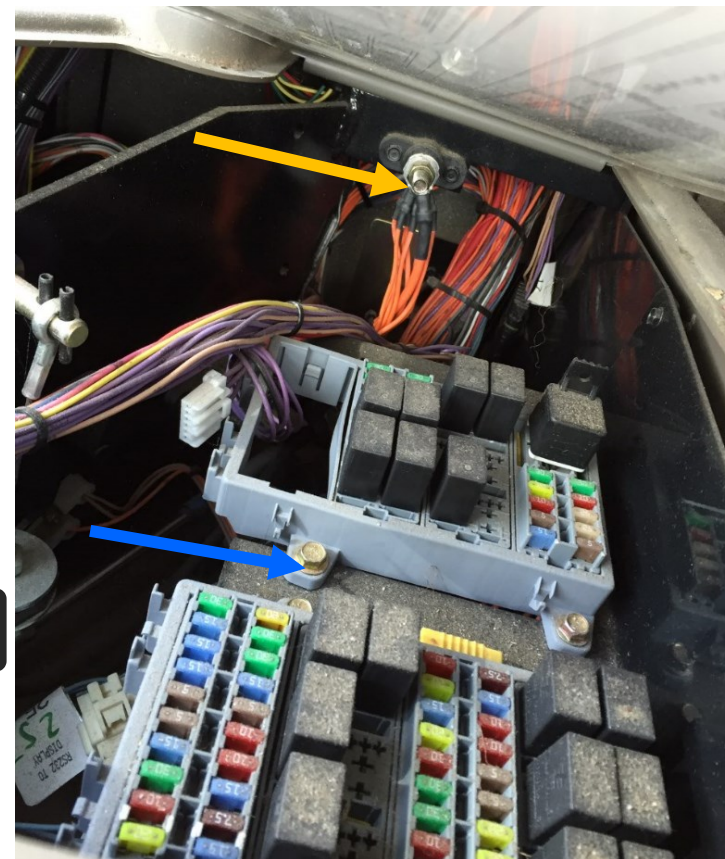

Figure 11

4. Cab Wiring Harness Installation

Refer to Figure 12

3. Locate Cab Extension Harness. It has a single plug on one end and two plugs on the other.
4. Plug the corresponding connector into the Power Harness.
5. Locate Foot Switch Controller that is supplied in wiring kit. Place in cab where desired. Route cord as best able to avoid congestion with feet and brake pedals.
6. Plug connector from Foot Switch Controller into connector on Cab Extension Harness.
7. Route Cab Extension Harness under the front lip of the floor mat as shown in the image.

Figure 12



4. Cab Wiring Harness Installation

Refer to Figure 13

8. Run the harness under the front lip of the floor mat and to the front bottom corner of the combine cab access door.

Refer to Figure 14

9. Run the excess length of the Cab Extension Harness in the corner of the doorway and under the walking platform.

Figure 14



Figure 13



4. Cab Wiring Harness Installation

Refer to Figure 15

10. Connect end of Cab Extension Harness to harness previously installed in access door area on the bottom side of the ladder landing.
11. Secure harness where you can to avoid damage during operation.
12. Tidy up harness in cab as best as possible to avoid damage.

Figure 15

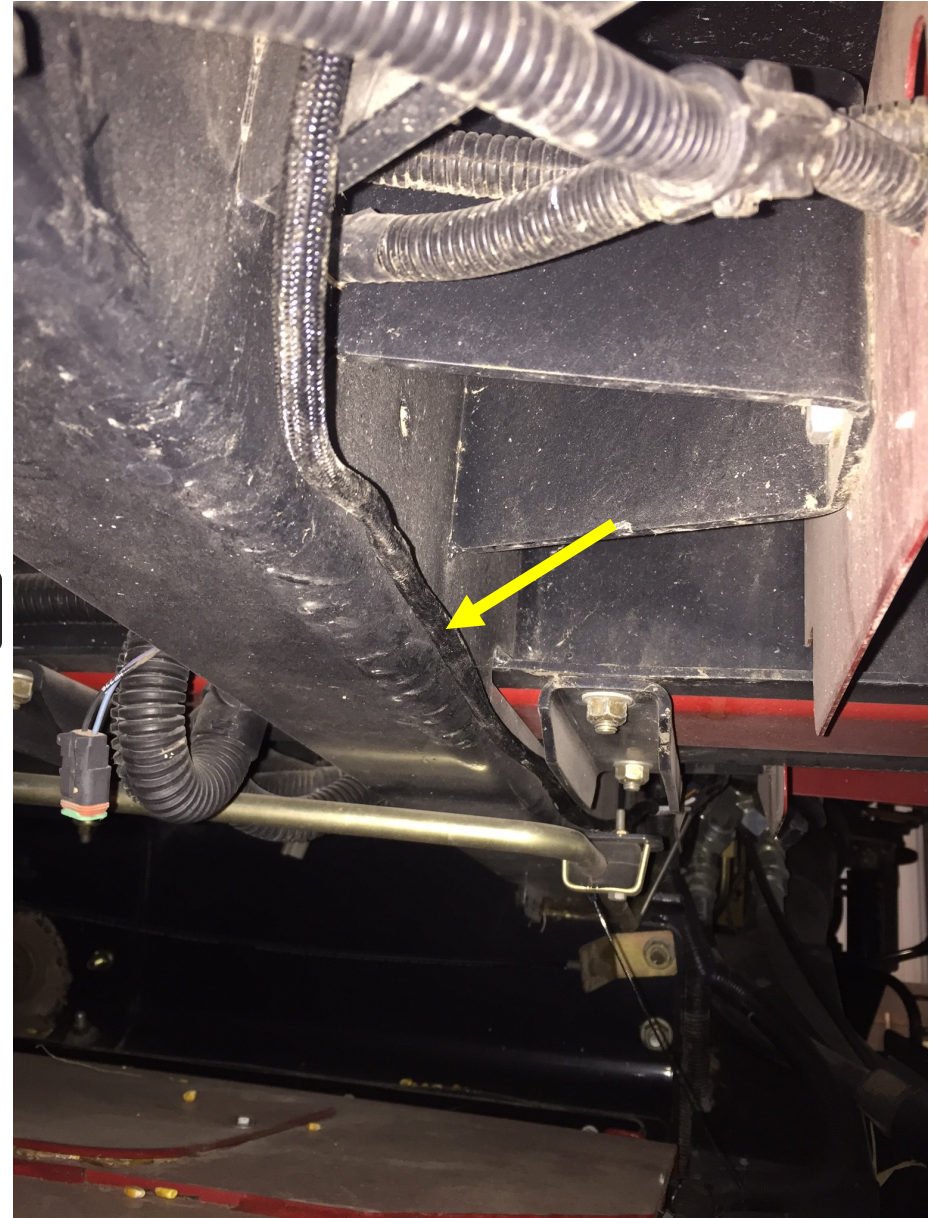

FOOT SWITCH Y721					
PIN	CIR #	LABEL	COLOR	GA	TYPE
A	001	GROUND	BLK	18	TXL
B	729	AUX SWITCH	DK GRN	18	TXL
C	012	12V POWER	RED	18	TXL



POWER Y569					
PIN	CIR #	LABEL	COLOR	GA	TYPE
A	012	12V POWER	RED	18	TXL
B	023	CHASSIS GND	BLK	12	GXL
C		PLUG			
D	016	BATTERY	RED	12	GXL



CLUTCH Y897					
PIN	CIR #	LABEL	COLOR	GA	TYPE
A	023	CHASSIS GND	BLK	12	GXL
B	170	CLUTCH	WHT	12	GXL
C	719	12V ENABLE	ORG	18	TXL

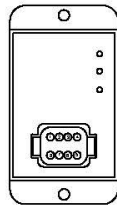
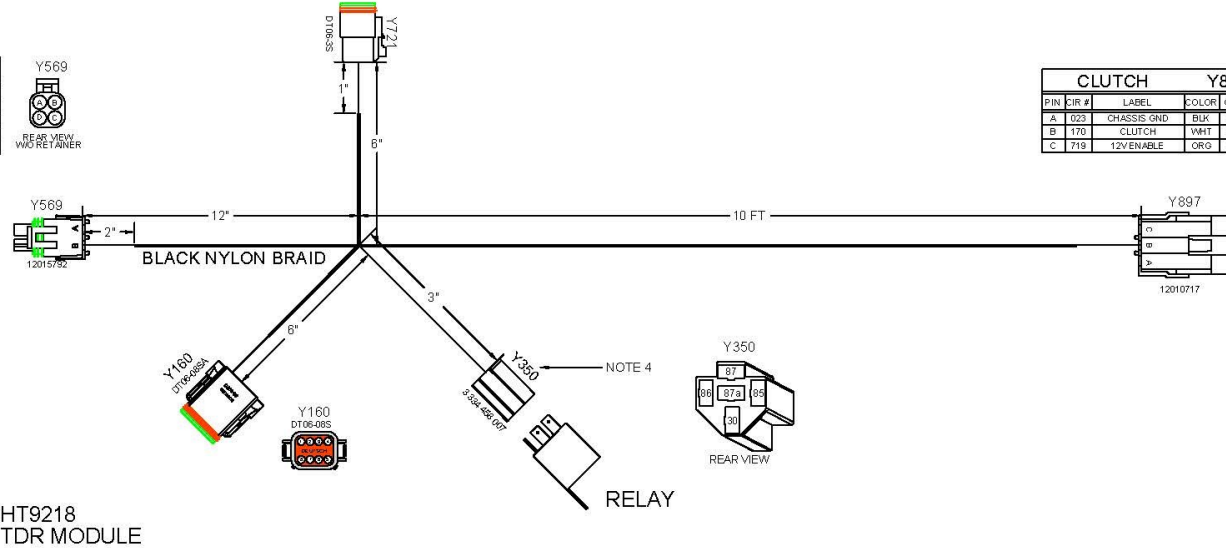

HT9218
TDR MODULE

TDR MODULE Y160					
PIN	CIR #	LABEL	COLOR	GA	TYPE
1	001	GROUND	BLK	17	TXL
2	719	12V ENABLE	ORG	18	TXL
3	729	AUX SWITCH	DK GRN	18	TXL
4	714	KEYED 12V	LI GRN	18	TXL
5		PLUG			
6		PLUG			
7		PLUG			
8	012	12V POWER	RED	18	TXL

RELAY 1 Y350					
PIN	CIR #	LABEL	COLOR	GA	TYPE
86	714	KEYED 12V	LI GRN	18	TXL
86	001	GROUND	BLK	18	GXL
30	016	BATTERY	RED	12	GXL
87a					
87	170	CLUTCH	WHT	12	GXL

ID LABEL	
OWNER	HEADSIGHT, INC
ITEM	SEE SHEET PART NUMBER
REVISION	SEE SHEET REV. #
DATE	BUILD DATE
MFG	SUPPLIER NAME

4 PIN #S SHOWN ON PLUG MAY NOT BE THE SAME AS STAMPED ON CONNECTOR (IF ANY). MAKE SURE WIRES MATCH TERMINAL DESIGNATION ON RELAY

1 LABEL EACH CONNECTOR WITH PART ID AND NAME

COMPONENT DATA

ITEM	PART ID	QTY	DESCRIPTION	MFG	MFG P/N	TERMINAL P/N	ACCESSORY P/N	ACCESSORY P/N
1	Y160	1	CONN, 8p PLUG	DEUTSCH	DT06-08SA	0462-201-16141	114017	WBS
2	Y350	1	CONN, RELAY	BOSCH/TCO	3 334 585 007	701235033	OR EQUIV.	
3	RELAY	1	RELAY, 30A AUTO, TAB	HELLA	4RD 007 794-031		OR EQUIV.	
4	Y569	1	CONN, 4p WP TOWER	DELPHI	12015798	(2) 12124581* (1) 12089188*	(2) 15324981* (1) 15324983*	12010300
5								
6	Y721	1	CONN, 3p PLUG	DEUTSCH	DT06-3S	0462-201-16141		WBS
7	Y897	1	CONN, 3p WP SHROUD	DELPHI	12010717	(2) 12124587* (1) 12089040*	(2) 15324981* (1) 15324983*	
8								
9								
10								*TO FIT WIRE

NOTES:

LANKOTA CLUTCH ADAPTER FOR CNH

REVISIONS			
REV	DESCRIPTION	DATE	APPROVED
4	TDR MODULE Y160	2.2.18	JHK



DRAWN 7/31/2018
DRAWN BY: JHK

FILE NAME

HT9261-CAB R4 CLUTCH CABLE LAYOUT

PART NUMBER	REV
HT9261-CAB	4
SCALE	SHEET
NOT TO SCALE	01

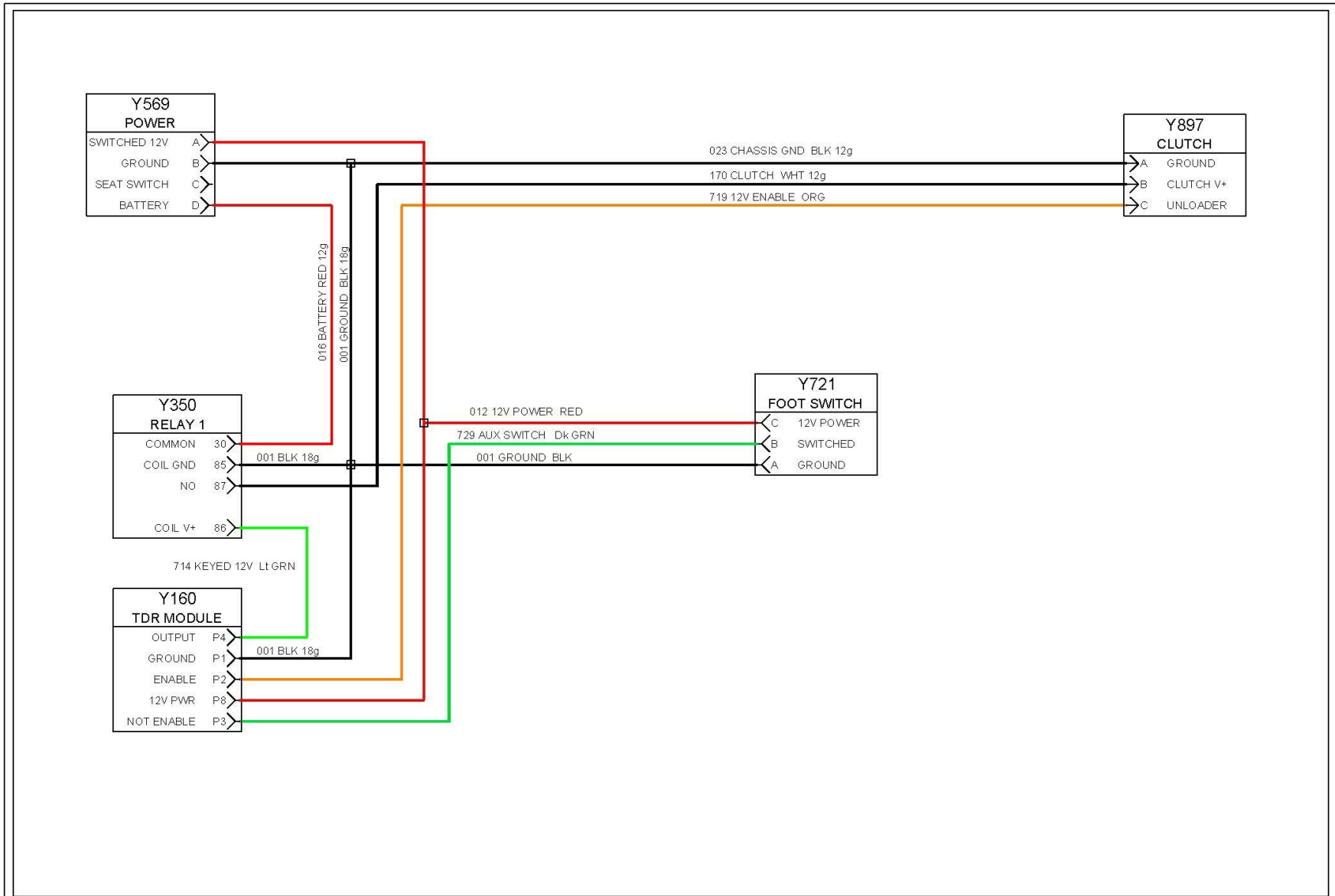

NOTES:
LANKOTA CLUTCH ADAPTER

REVISIONS			
REV	DESCRIPTION	DATE	APPROVED

FILE NAME
HT9261-CAB R4 CLUTCH
WIRING SCHEMATIC

PART NUMBER
HT9261-CAB

SCALE: NOT TO SCALE

DRAWN 7/31/2018	REV 4
DRAWN BY: JHK	SHEET 02

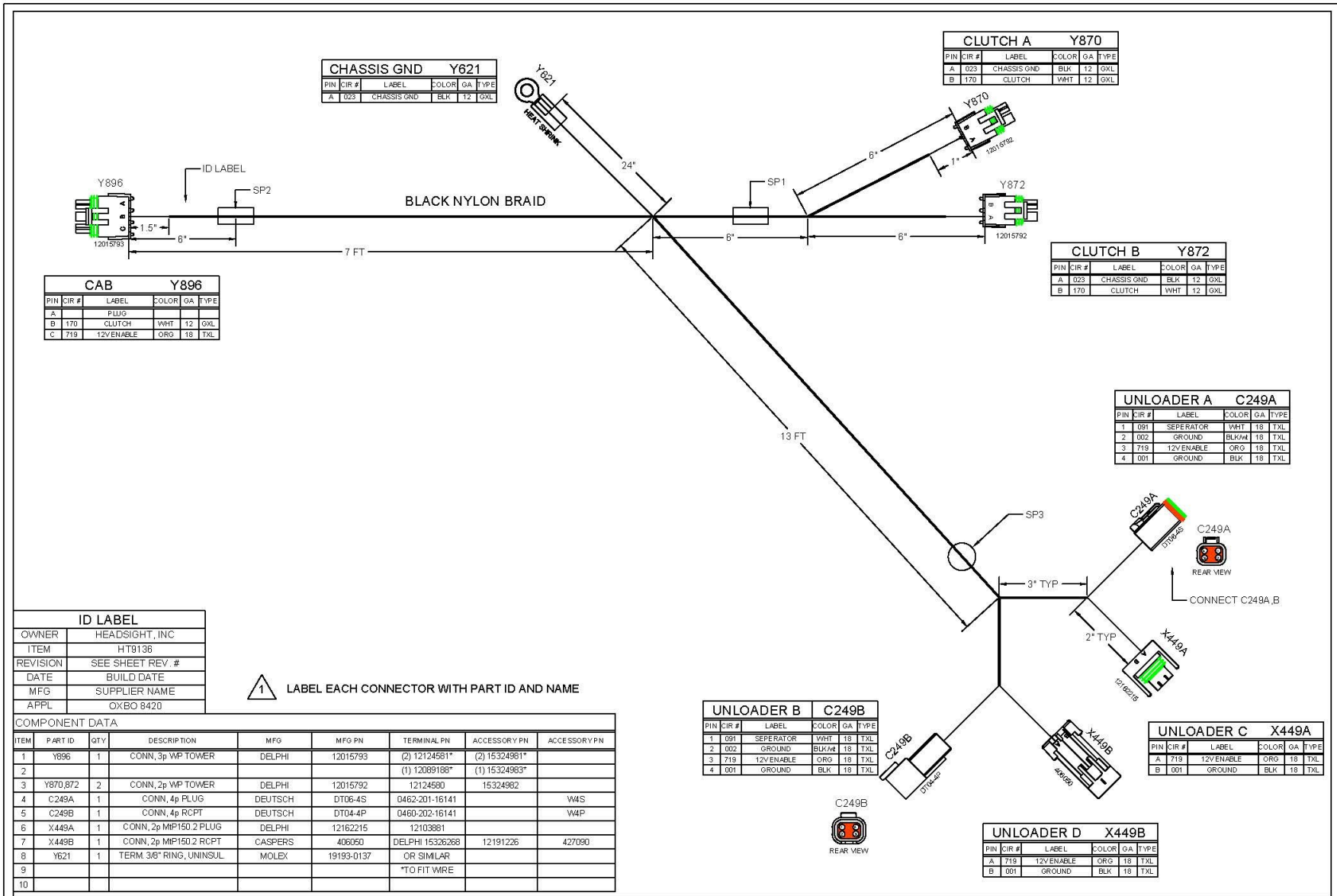

ID LABEL	
OWNER	HEADSIGHT, INC
ITEM	HT9136
REVISION	SEE SHEET REV. #
DATE	BUILD DATE
MFG	SUPPLIER NAME
APPL	OXBO 8420

1 LABEL EACH CONNECTOR WITH PART ID AND NAME

COMPONENT DATA								
ITEM	PART ID	QTY	DESCRIPTION	MFG	MFG PN	TERMINAL PN	ACCESSORY PN	ACCESSORY PN
1	Y896	1	CONN, 3p WP TOWER	DELPHI	12015793	(2) 12124581*	(2) 15324981*	
2						(1) 12089188*	(1) 15324983*	
3	Y870,872	2	CONN, 2p WP TOWER	DELPHI	12015792	12124580	15324982	
4	C249A	1	CONN, 4p PLUG	DEUTSCH	DT06-4S	0462-201-16141		W4S
5	C249B	1	CONN, 4p RCPT	DEUTSCH	DT04-4P	0460-202-16141		W4P
6	X449A	1	CONN, 2p MPI150 2 PLUG	DELPHI	12162215	12103881		
7	X449B	1	CONN, 2p MPI150 2 RCPT	CASPERS	406050	DELPHI 15326288	12191226	427090
8	Y621	1	TERM 3/8" RING, UNINSUL	MOLEX	19193-0137	OR SIMILAR		
9						*TO FIT WIRE		
10								

NOTES:
 LANKOTA CLUTCH ADAPTER
 CIH FLAGSHIP & MIDRANGE
 2 for use with HT9261-CAB r3

REVISIONS			
REV	DESCRIPTION	DATE	APPROVED
2	GROUNDING	9.27.17	JHK

HEADSIGHT
 HARVESTING SOLUTIONS

DRAWN 9/27/2017
 DRAWN BY: JHK

FILE NAME	HT9261-CL R2 CLUTCH CABLE LAYOUT	
PART NUMBER	HT9261-CL	REV 2
SCALE	NOT TO SCALE	SHEET 01

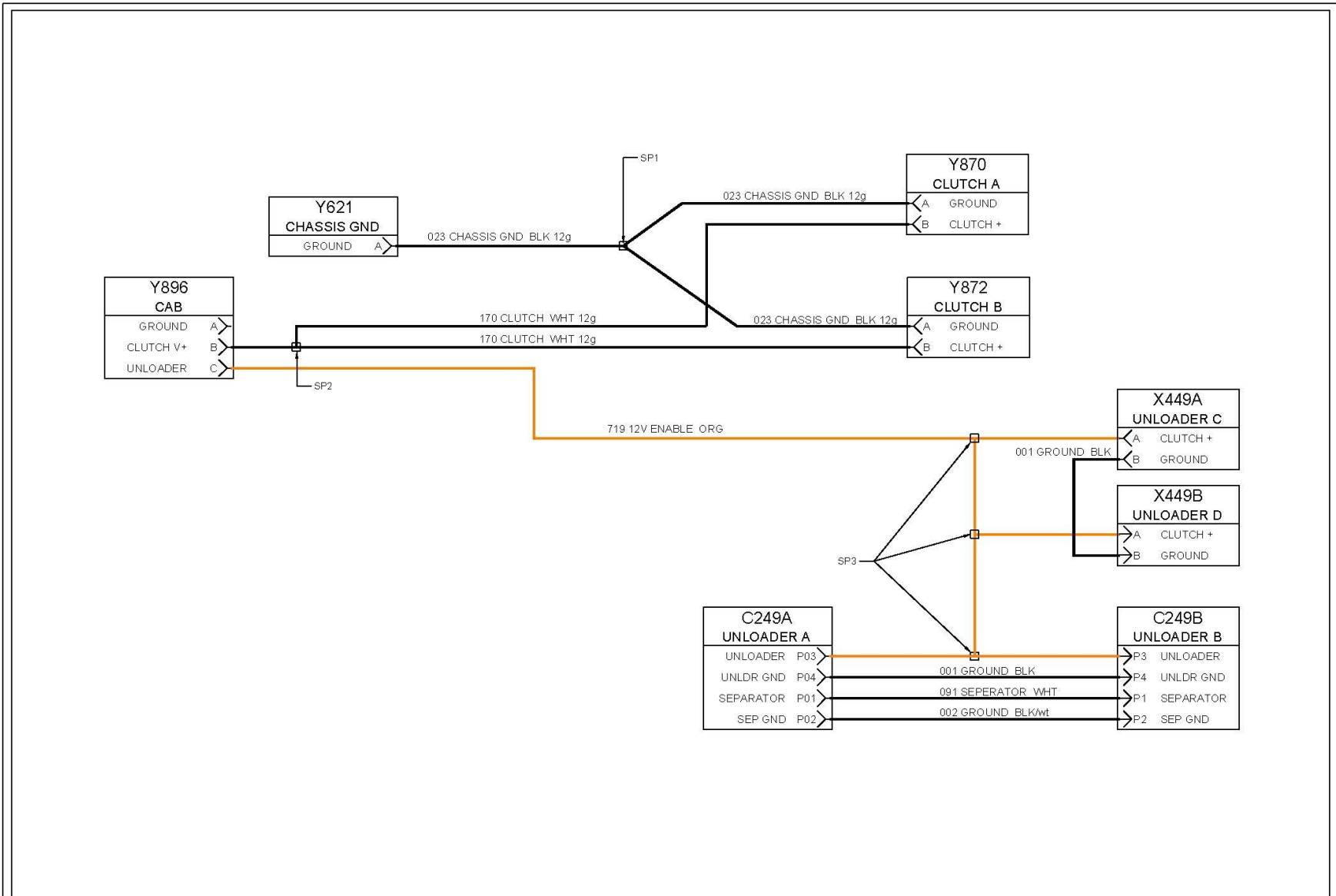

NOTES:
LANKOTA CLUTCH ADAPTER
CIH FLAGSHIP & MIDRANGE

REVISIONS			
REV	DESCRIPTION	DATE	APPROVED

FILE NAME
HT9261-CL R2 CLUTCH WIRING SCHEMATIC

PART NUMBER
HT9261-CL

SCALE **NOT TO SCALE** SHEET **02**

DRAWN 9/27/2017	REV	2
DRAWN BY: JHK		

UNLOADER B C249B					
PIN	CIR #	LABEL	COLOR	GA	TYPE
1					
2					
3	719	12V ENABLE	ORG	18	TXL
4					

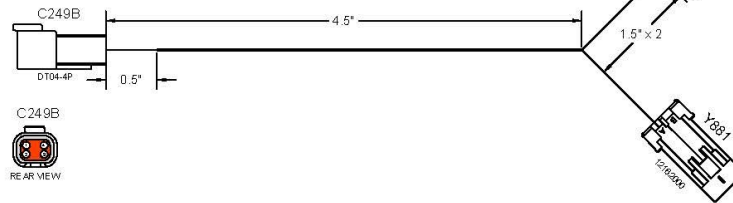

SOLENOID Y880					
PIN	CIR #	LABEL	COLOR	GA	TYPE
A	001	SIGNAL GND	BLK	18	TXL
B	719	12V ENABLE	ORG	18	TXL

OEM HARNESS Y881					
PIN	CIR #	LABEL	COLOR	GA	TYPE
A	001	SIGNAL GND	BLK	18	TXL
B	719	12V ENABLE	ORG	18	TXL

ID LABEL	
OWNER	HEADSIGHT, INC
ITEM	SEE SHEET PART NUMBER
REVISION	SEE SHEET REV #
DATE	BUILD DATE
MFG	SUPPLIER NAME

- 2 TXL WIRE INSULATION MAY NOT EXCEED 0.078" (2MM) DIA.
- 1 LABEL EACH CONNECTOR WITH PART ID AND NAME

COMPONENT DATA								
ITEM	PART ID	QTY	DESCRIPTION	MFG	MFG P/N	TERMINAL P/N	ACCESSORY P/N	ACCESSORY P/N
1	C249B	1	4p CONN, RCPT	DEUTSCH	DT04-4P	0460-202-16141	114017	W4P
2	Y880	1	2p CONN, MPACK PLUG	DELPHI	12052641	12048074	15324973	12052634
3	Y881	1	2p CONN, MPACK RCPT	DELPHI	12162000	12045773	15324973	12052634
4								
5								
6								
7								
8								
9								
10								

NOTES:
FOR 2017--> x140 MIDRANGE COMBINES

REVISIONS			
REV	DESCRIPTION	DATE	APPROVED
1	CREATED PART	9.27.17	JHK



FILE NAME	
HT9261-MP R1 CLUTCH CABLE LAYOUT	
PART NUMBER	REV
HT9261-MP	1
SCALE NOT TO SCALE	SHEET 01

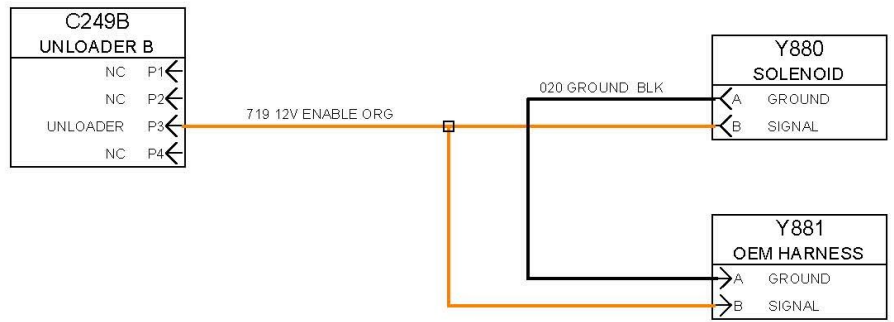

NOTES:

REVISIONS			
REV	DESCRIPTION	DATE	APPROVED

HEADSIGHT
HARVESTING SOLUTIONS

DRAWN 9/27/2017
DRAWN BY: JHK

FILE NAME		HT9261-MP R1 CLUTCH WIRING SCHEMATIC	
PART NUMBER	HT9261-MP	REV	1
SCALE	NOT TO SCALE	SHEET	02



HT9218 MODULE

DIAGNOSTICS ASSIST

09062027a

Description

The HT9218 TDR Module is used with the Lankota "Cross Auger Clutch Kit". It operates as both a logic module and a Delay Timer to allow the main auger to start first, then engage the cross augers.

Functionality

The module operates on 12V DC, has 2 inputs, and a single output.

- Pin 1 = Ground
- Pin 6 = +12V power supply
- CNH - Keyed 12V
- JD - Unloader clutch 12V (same as pin 3)
- Pin 3 is the Enable input from the OEM unloader clutch
 - V > 9V or 25% PWM, Enable output (with time delay)
- Pin 2 is the Disable input from the foot switch
 - V > 9V or 25% PWM, Turn OFF output
- Pin 4 is the Output pin, used to turn on the cross-auger clutch relay



Indicators

The unit has 3 LED indicators to assist Troubleshooting:

- GREEN - Power: nominal +12V supply to unit
- YELLOW - Enable is Active (OEM Unloader Clutch > 9V or 25% PWM)
- RED - Output is ON

Correct Operation

1. When the OEM unloading auger is NOT running:
 - JD - No LED's are on
 - CNH - Only Green LED is ON (whenever the combine key is on)
2. Green & Yellow LEDs both ON whenever the OEM unloading auger clutch is engaged.
3. Red LED turns ON after Time delay (4-6 seconds), relay closes, cross auger clutches engage.
4. Pressing the foot switch immediately stops augers, releasing foot switch immediately starts augers.

LED Diagnostics

The following requirements must be met before testing:

- Key on, combine engine running . Unloader running

Step thru the chart by Light Function

- STEP 1 - Is the Green Light working properly?
- STEP 2 - Is the Yellow Light working properly?
- STEP 3 - Is the Red Light working properly?

Measure voltages, etc in 6 pin plug that connects to module. not on actual module pins.

Error Code	Problem	Solution
No Green Light OE Unloader running	No Ground - Test Continuity, Pin 1 in plug to Frame Ground	Repair wire or find better ground bolt
	No 12V, CNH - Measure Pin 6 in plug to Frame Ground	Check 12V supply in cab, or wiring
	No 12V, JD - Measure Pin 6 in plug to Frame Ground	See No Yellow Light, OEM Unloader running
	12V, Pin 6 to Pin 1 in plug	Replace Module
No Yellow Light OEM Unloader Running	No Voltage - Not connected to Unloader Clutch plug.	Find correct plug (see Install Manual)
Test Pin 3 in plug to frame ground JD - 11-13V CNH - 6-13V	No Voltage - Orange wire broken. Test continuity from Pin 3 in plug to orange wire in any of the Unloader Clutch Tee plugs	Repair wire Check 3 Pin WP connection Y896/Y897
	JD - Y540/Y541, Y874,Y875 CNH - C249, X449	
No RED Light OEM Unloader running. Time Delay > 6 seconds after starting Unloader	No Ground - Test Continuity, Pin 1 in plug to Frame Ground	Repair wire or find better ground bolt
	Voltage as shown, Pin 3 to Pin 1 in plug	Replace Module
	Foot Switch ON Disconnect foot switch plug Y721	Test foot switch or wiring
	Defective module	Replace Module
All Lights ON, Cross Augers not energized (No 12V A-B in clutch plugs)	No Battery Power Measure large Red Wire at relay	Connect Red wire, Check Fuse, repair wire
	Defective Power Relay	Replace Relay
	Clutches not Grounded	Check Ground bolt connection in clutch harness

Finishing

1. Make one final check to complete wiring harness to ensure there are no points in the harness that will come in contact with anything that may damage harness during combine operation and/or L/H main access door opening and closing.
2. Do a final check of all nuts, bolts etc. installed to make sure they are all tight and secure.

DO NOT USE WITH AN AUTOMATIC LUBRICATION SYSTEM!

Test Run & Burnish

Test run the system. The unloading auger system should work exactly the same as it did before you installed this kit except when the foot switch is engaged the two grain tank cross augers will stop turning allowing the unloading auger to empty out roughly 85 - 90%. As soon as pressure is released from the foot switch the augers will reengage. This means that anytime you want the cross augers not to turn, you must have your foot on the foot switch.

The initial burnish process of the clutches contained in this kit has been performed by Lankota prior to shipment. Seasonal reburnishing of the clutches at the beginning of every harvest season will greatly increase the life of your clutch system.

To burnish the clutches:

1. Swing out the auger.
2. Start the unloading auger.
3. Run the combine on high idle.
4. Press and release the foot switch 5-10 times.

**THESE TIPS NEED TO REMAIN IN THE COMBINE
WITH THE OPERATOR AT ALL TIMES**

**TIPS TO ENSURE LONG LIFE OF YOUR LANKOTA
GRAIN TANK CROSS AUGER CLUTCH SHUT OFF SYSTEM**

WIRING SYSTEM NEEDS GROUNDED TO THE BATTERY:

(John Deere® Kits Only) Most kits have been installed with the grounding wire attached to a bolt usually above the battery box. Even though there might be factory wiring grounded to this bolt, it is **NOT** a sufficient ground for the clutch kit. **For Pre “S” Series Combines**, remove the battery box lid and attach the ground wire to the **SWITCHED** side of the battery cut off switch. Do not connect to the side of the switch that is directly connected to the **BATTERY** ground, that will drain your battery. **On “S” Series Combines**, attach ground wire directly to the battery.

BURNISH CLUTCHES REGULARLY:

If you have not used the unloading auger clutch system for several days, such as at the beginning of every season, or after a weather delay, make sure to run the engine at high RPM, engage the unloading auger system with an empty grain tank and slowly cycle the foot pedal on and off 15 – 20 times to clean the surfaces of the clutch. This will rid the mating surfaces of rust and dirt which can cause the clutch to slip.

GRAIN TANK CROSS AUGER COVERS:

For high moisture crops (corn especially), put the grain tank cross auger covers in the **DOWN** position on the far **RIGHT** side of the grain tank. Put them in the UP position on the auger side or left side of the grain tank. This will minimize compacting the wet corn under the auger covers.

MAKE SURE GRAIN TANK SUMP IS CLEAN:

Even if you put your combine in a shed **EVERY NIGHT**, there still will be dirt and build up in your grain tank sump. As a rule of thumb, with a clutch kit installed or not, you should drain and clean out the sump **WEEKLY**, even if there is not wet material present. Cleaning out the sump will guarantee you do not have any clumps of rotten grain, hard dirt or ice hindering the flow of grain.

NEVER LEAVE WET GRAIN IN THE GRAIN TANK:

Never leave high moisture grain in the grain tank for long periods of time. This will settle and act like cement causing many problems.

For any questions, comments or concerns, please contact Lankota @ 866 – 526 – 5682. We are happy to help you have the best harvesting experience possible. After hours and weekend emergency tech support available by calling the above phone number.